



FONTS

	PRODUCT INFO		FONT DIMENSIONS			PACKAGING		
	NAME ORDER CODE	DIMENSIONS INCL. DRIP TRAY (D x W x H mm)	DIMENSIONS EXCL. DRIP TRAY (D x W x H mm)	TAP TO COUNTER (T mm)	PACKED WEIGHT	PACKAGING DIMENSIONS (L x W x H mm)	QTY/ PALLET	
	1B Una Font 1000859	168 x 120 x 287	138 x 30 x 287	233	2kg	290 x 570 x 215	30	
	3b MIX Font 1000879			247				

OR

BOILERS

NAME ORDER CODE	SIZE	PERFORMANCE SPECS			PLUMBING & ELECTRICAL REQS		PACKAGING		
	DIMENSIONS (D x W x H mm)	IMMEDIATE DRAW OFF	L/HR	CUPS /HR	POWER @220V	PLUMBING REQS	PACKAGING DIMENSIONS (L x W x H mm)	PACKED WEIGHT	QTY/ PALLET
MIX UC3 1000880	385 x 210 x 444	3L	28L	156	2.8kW	3/4" BSP	450 x 290 x 540	11kg	18
MIX UC8 1000887	385 x 210 x 617	8L					450 x 290 x 700	14kg	24



1 BUTTON UNA FONT WITH MIX UC3/UC8

COUNTER CUT-OUT WITH DRIP TRAY	1b UNA FONT 1000859	
	MIX UC3 1000880	MIX UC8 1000887

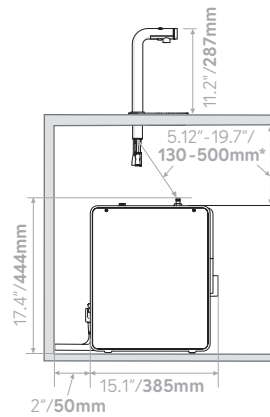
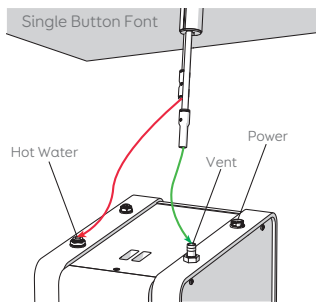
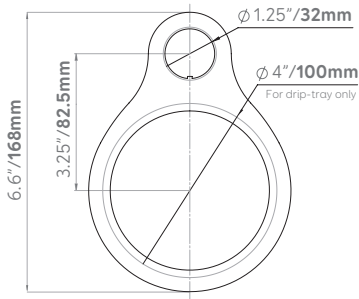

* Hosing should be trimmed to ensure continuous drop from font to boiler

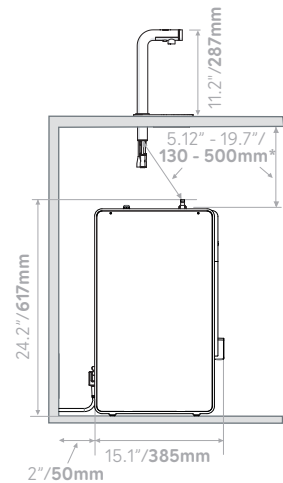

* Hosing should be trimmed to ensure continuous drop from font to boiler

VENTILATION REQUIREMENTS

50mm/1.9" clearance required at each side and back of machine if installed in an enclosed cabinet.

ELECTRICAL INSTALLATION PROCEDURE

When installing the machine, always observe the local regulations and standards. The standard machine is supplied with a UK 3-pin plug. For EU models a 2-pin CEE-7 plug will be supplied. US models will be supplied with the suitable plug. A suitable mains power supply socket should be available within easy access of the appliance so that it can be disconnected easily after install.

PLUMBING INSTALLATION PROCEDURE

- Ensure that the equipment is installed according to local plumbing & water regulations.
- Mains water pressure required (limits): 14.5 - 145psi (100 - 1000kPa, 0.1 - 1MPa).
- Requires inline water filter within your water specifications.
- The machine is supplied with a 3/4" BSP connection.
- Turn on the water to flush any impurities, dust etc from the inlet hose and water pipe. Allow several litres through. Especially for new installations.

- Connect the hose to the inlet valve of the boiler. Make sure a sealing washer is fitted.
- Turn on water and check for leaks.

OPERATING BOILER FOR THE FIRST TIME

- Check that all installation procedures have been carried out.
- Ensure water valve is on.
- Plug boiler into suitable socket.
- Turn on the power switch.
- The "Wait" progress circle will be visible on the screen and the machine will fill to a safe level, above the elements, before heating.
- The "Ready" tick will come up on screen when the machine is full and up to normal operating temperature (approx. 10/20 mins.).
- The boiler is now ready for use - the display will show the button settings and the "Ready" status tick.
- The Boiler may now be used to dispense Hot Water to the preset factory settings.

NOTE: Because the boiler is electronically controlled no priming is necessary. The element cannot switch on until a safe level of water is reached.



MIX 3 BUTTON FONT WITH MIX UC3/UC8

COUNTER CUT-OUT WITH DRIP TRAY	MIX 3b FONT 1000879	
	MIX UC3 1000880	MIX UC8 1000887

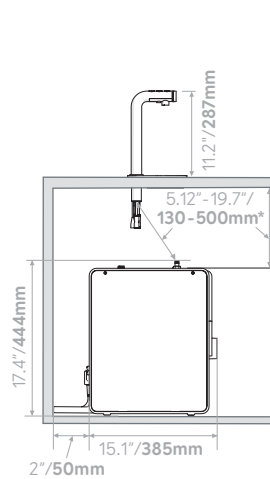
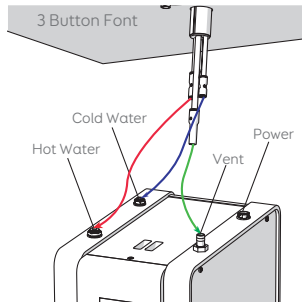
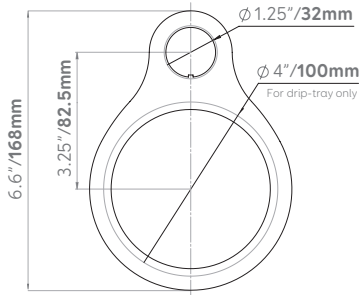

* Hosing should be trimmed to ensure continuous drop from font to boiler

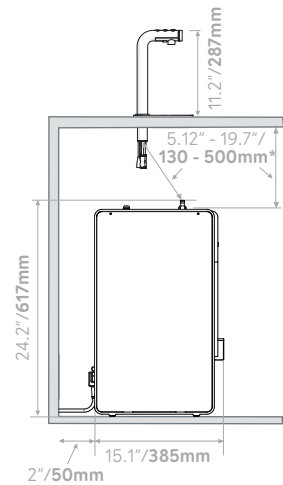

* Hosing should be trimmed to ensure continuous drop from font to boiler

VENTILATION REQUIREMENTS

50mm/1.9" clearance required at each side and back of machine if installed in an enclosed cabinet.

ELECTRICAL INSTALLATION PROCEDURE

When installing the machine, always observe the local regulations and standards. The standard machine is supplied with a UK 3-pin plug. For EU models a 2-pin CEE-7 plug will be supplied. US models will be supplied with the suitable plug. A suitable mains power supply socket should be available within easy access of the appliance so that it can be disconnected easily after install.

PLUMBING INSTALLATION PROCEDURE

- Ensure that the equipment is installed according to local plumbing & water regulations.
- Mains water pressure required (limits): 14.5 - 145psi (100 - 1000kPa, 0.1 - 1MPa).
- Requires inline water filter within your water specifications.
- The machine is supplied with a 3/4" BSP connection.
- Turn on the water to flush any impurities, dust etc from the inlet hose and water pipe. Allow several litres through. Especially for new installations.

- Connect the hose to the inlet valve of the boiler. Make sure a sealing washer is fitted.
- Turn on water and check for leaks.

OPERATING BOILER FOR THE FIRST TIME

- Check that all installation procedures have been carried out.
- Ensure water valve is on.
- Plug boiler into suitable socket.
- Turn on the power switch.
- The "Wait" progress circle will be visible on the screen and the machine will fill to a safe level, above the elements, before heating.
- The "Ready" tick will come up on screen when the machine is full and up to normal operating temperature (approx. 10/20 mins.).
- The boiler is now ready for use - the display will show the button settings and the "Ready" status tick.
- The Boiler may now be used to dispense Hot Water to the preset factory settings.

NOTE: Because the boiler is electronically controlled no priming is necessary. The element cannot switch on until a safe level of water is reached.