





MIX FONTS WITH UNDERCOUNTER WATER BOILERS

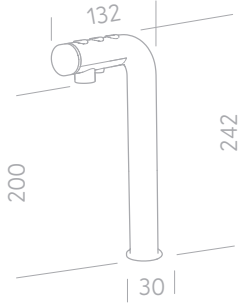

MIX 3 BUTTON FONT 1000879	MIX 1 BUTTON FONT 1000878	DIMENSIONS
		
<ul style="list-style-type: none"> • 3 or 8 litre options • Vacuum insulated tank for up to 70% more energy-efficiency 	<ul style="list-style-type: none"> • Counter cut-outs required • 28 litre output per hour • 156 cups (180ml) per hour 	

ASSOCIATED PRODUCTS (SOLD SEPARATELY)

REQUIRED	
MIX UC3 1000880	MIX UC8 1000887
	OR
	

FONTS

OPTIONAL		
DRIP TRAY 2300268		
NAME ORDER CODE	DIMENSIONS (D x W x H mm)	TAP TO COUNTER (T mm)
MIX 1 Button Font 1000878	30 x 30 x 242	200
MIX 3 Button Font 1000879	30 x 30 x 242	200

BOILERS

NAME ORDER CODE	POWER @ 230V	IMMEDIATE DRAW OFF	DIMENSIONS (D x W x H mm)	PLUMBING REQS
MIX UC3 1000880	2.8kW	3 L	385 x 210 x 444	3/4" BSP
MIX UC8 1000887	2.8kW	8 L	385 x 210 x 617	3/4" BSP

PACKAGING

NAME ORDER CODE	PACKED WEIGHT	PACKAGING DIMENSIONS (L x W x H mm)	QUANTITY PER PALLET
MIX UC3 1000880	11kg	450 x 290 x 540	24
MIX UC8 1000887	14kg	450 x 290 x 700	18
MIX 1 Button Font 1000878	2kg	290 x 570 x 215	30
MIX 3 Button Font 1000879	2kg	290 x 570 x 215	30

STYLISH, SPACE-SAVING FONT WITH PROGRAMMABLE UNDERCOUNTER BOILER TO DISPENSE THREE TEMPERATURES, THREE VOLUMES IN AN INSTANT.

MIX FONTS WITH UNDERCOUNTER WATER BOILERS



MIX 1 OR 3 BUTTON FONTS WITH MIX UC3/UC8

COUNTER CUT-OUT WITH DRIP TRAY

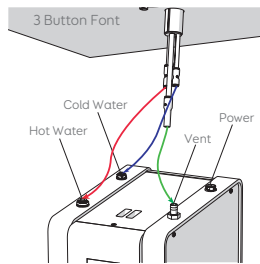
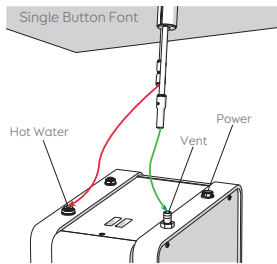
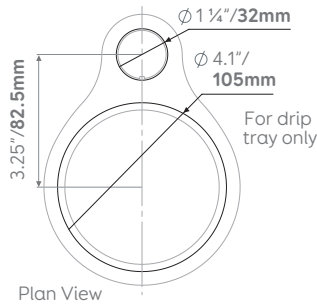

MIX 3 BUTTON FONT 1000879
MIX 1 BUTTON FONT 1000878

MIX UC3 1000880

MIX UC8 1000887

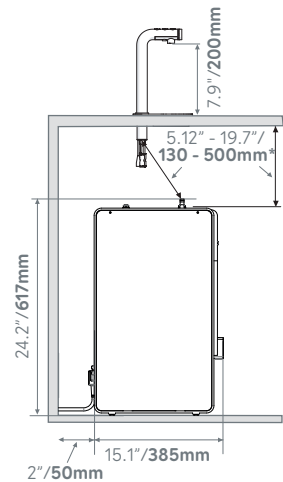
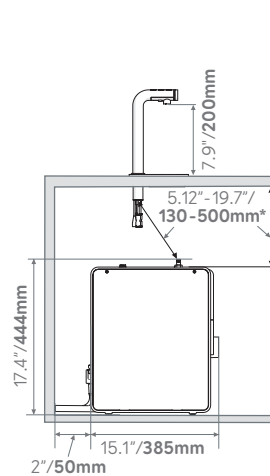

* Hosing should be trimmed to ensure continuous drop from font to boiler

* Hosing should be trimmed to ensure continuous drop from font to boiler

VENTILATION REQUIREMENTS

50mm/1.9" clearance required at each side and back of machine if installed in an enclosed cabinet.

ELECTRICAL INSTALLATION PROCEDURE

When installing the machine, always observe the local regulations and standards. The standard machine is supplied with a UK 3-pin plug. For EU models a 2-pin CEE-7 plug will be supplied. US models will be supplied with the suitable plug. A suitable mains power supply socket should be available within easy access of the appliance so that it can be disconnected easily after install.

PLUMBING INSTALLATION PROCEDURE

- Ensure that the equipment is installed according to local plumbing & water regulations.
- Mains water pressure required (limits): 14.5 - 145psi (100 - 1000kPa, 0.1 - 1MPa).
- Requires inline water filter within your water specifications.
- The machine is supplied with a 3/4" BSP connection.
- Turn on the water to flush any impurities, dust etc from the inlet hose and water pipe. Allow several litres through. Especially for new installations.

- Connect the hose to the inlet valve of the boiler. Make sure a sealing washer is fitted.
- Turn on water and check for leaks.

OPERATING BOILER FOR THE FIRST TIME

- Check that all installation procedures have been carried out.
- Ensure water valve is on.
- Plug boiler into suitable socket.
- Turn on the power switch.
- The "Wait" progress circle will be visible on the screen and the machine will fill to a safe level, above the elements, before heating.
- The "Ready" tick will come up on screen when the machine is full and up to normal operating temperature (approx. 10/20 mins.).
- The boiler is now ready for use - the display will show the button settings and the "Ready" status tick.
- The Boiler may now be used to dispense Hot Water to the preset factory settings.

NOTE: Because the boiler is electronically controlled no priming is necessary. The element cannot switch on until a safe level of water is reached.