

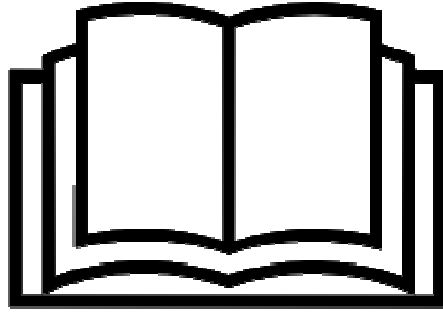

Marco Beverage Systems Ltd.



INSTRUCTIONS FOR MODEL

Uber Boiler

Part/Model Number: 1000680# 1000681
(where # is a suffix of one or more alphanumeric characters)

INCORPORATING SOFTWARE 1.10

Water pressure : 5 - 50 psi (min.-max.)35 - 345 kPa (min.-max.)

Marco Beverage Systems Limited. 63d Heather Road, Sandyford Industrial Estate, Dublin 18.	Marco Beverage Systems Limited. Shire House, Strixton Manor, Strixton, Wellingborough, Northants, NN29 7PA
Ireland Tel: +353 (0)1 295 2674 Ireland Fax: +353 (0)1 295 3715 email: sales@marco.ie www.marco.ie	UK Tel: +44 (0)2072 744 577 UK Fax: +44 (0)2079 788 141 email: sales@marco-bev.co.uk www.marco-bev.co.uk

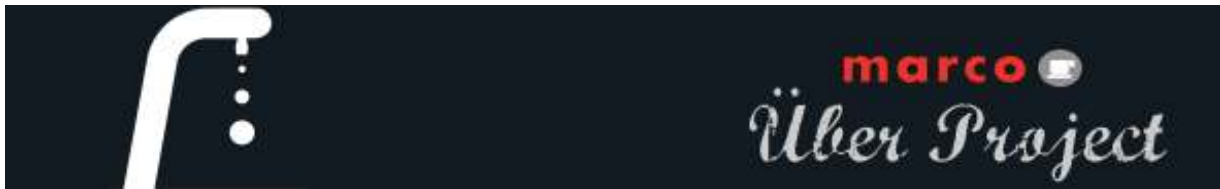

UNIT INSTALLATION INFORMATION

SAFETY:

- **Risk of scalding.** Beware of accidentally operating the water drawoff dial or push buttons especially when cleaning. If the dial is left in the ON position (shown later) then pressing boost will cause water to flow immediately from the font.
- This appliance must be earthed. If the plug supplied is not used then ensure that the green/yellow cable is connected to a suitable earth.
- Risk of flooding –inlet hose. The hose supplied with this unit is non-toxic food quality tested to 190psi. However, a hose is not a permanent connection. It is, therefore, advisable to switch off boiler and close the stopcock valve when boiler is not in use, e.g. overnight, weekends etc.
- Risk of flooding –overflow hose. Water spilling in the scale platform area will run down a waste tube which should be plumbed –this is not intended to be used as a dedicated drain facility. If a waste bucket is used it risks overflowing.
- The utmost care has been taken in the manufacture and testing of this unit. Failure to install, maintain and / or operate this boiler according to the manufacturer's instructions may result in conditions that can cause injury or damage to property. If in any doubt about the serviceability of the boiler always contact the manufacturer or your own supplier for advice.
- Children should be supervised to ensure that they do not play with the appliance
- In the event any wires are damaged, such wires can only be replaced by experts or professional afterservice staff from the manufacturer, afterservice department or similiar function departments.

INSTALLATION DETAILS:

Electrical installation:

- Electrical specification: 2.8kW-230V-50Hz
- The electrical power supply must be connected in accordance with the applicable regulations of the country of installation.

Plumbing installation procedure:

- Mains water pressure required (limits): 5-50psi (35-345kPa)
- Fit a stop Valve on a cold water line and attach a 3/4" BSP male fitting, (e.g. 3/4" x 1/2" 311 or washing machine type stop valve).
- For US versions use 3/8" NPT male fitting.
- Connect straight tailpiece of the hose to the stop valve fitting. Make sure that the pre-attached sealing washer is fitted.



- Turn on the water to flush any impurities, dust etc from the inlet hose and water pipe. Allow several gallons through.
- Connect right-angled tailpiece of the hose to the inlet valve of the boiler (3/4" BSP). Make sure the sealing washer is fitted here also.
- Turn on water and check for leaks.

CLEANING:

The exterior of these machines may be cleaned with a damp cloth and a light detergent. Do not use abrasive cloths or creams, as this will spoil the finish of the machine. Do not use a water jet or spray.

NB: Beware of accidentally operating the Font Dial or buttons when cleaning the front of the machine.

LIMESCALE:

In common with all water boiler manufacturers, service calls resulting from limescale are not covered by warranty. Fitting a scale reducer is recommended, especially in hard water areas. This can reduce the build-up of scale but may not stop it altogether. The frequency that descaling is required depends on the local water supply; hard water areas need more attention. Descaling of the machine should ideally be carried out by qualified service personnel.

Descale agents/solution should be added to the Tank via the large tube as in photo. Follow in the descale agent instructions.



Descale Tube at front of Unit

Location of On/Off Switch – under the unit



COUNTER CUTOUT:

- NEVER lift or lower the unit by holding the front!—use the upper wide tile or lift from the base.
- The unit requires a counter thick enough to support the weight of the machine when full, when full it could be up to 30kg in total.
- Never overload the scale platform with a force greater than 9kg.
- Ensure the flow control dial is in the OFF position as shown below.

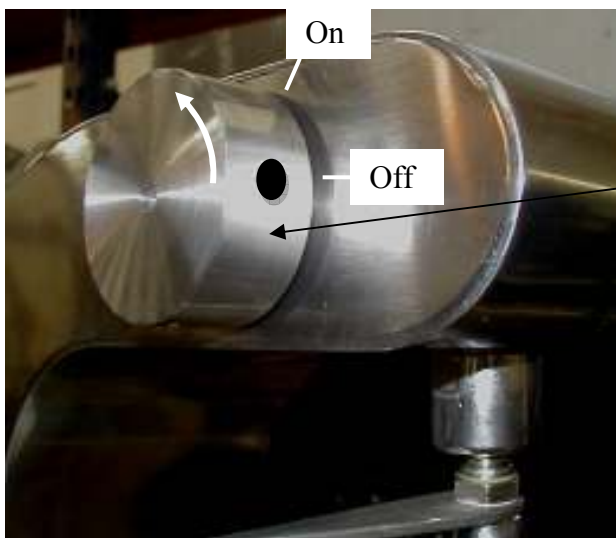

The Font Dial operates anticlockwise to begin the flow of water.

- Check the dimensions shown for the counter cutout and the upper tile, leave adequate clearance on your counter top and check the space below the counter/cabinet to ensure there is enough room.
- Cut out the counter top to be 410x195mm, this dimension includes clearance/tolerance space for the lower part of the machine (the actual machine is approx 405x190mm). The full dimensions are shown on the following page.
- Hold the machine by the tile and slowly lower it down into the cutout, it is advisable to wear thick work gloves. A second person may be needed who could hold the machine at the bottom. Be careful not to trap fingers under the tile as it is lowered.
- The weight of the machine when filled should be enough to ensure it is not moving. If further fixing is required it silicone can be used to stick the tile to the counter—but it is advisable to leave the machine free to be taken out for servicing purposes.

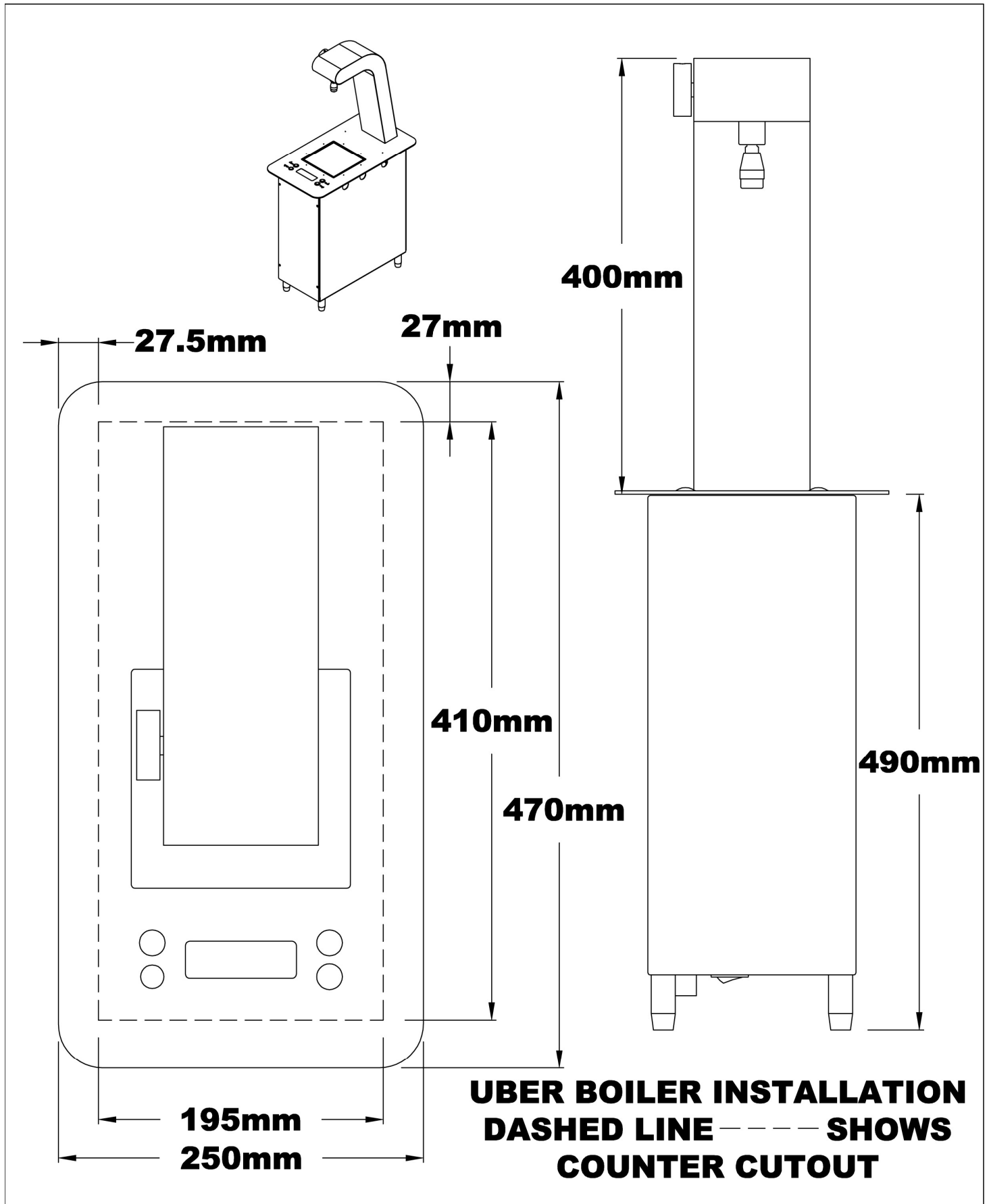

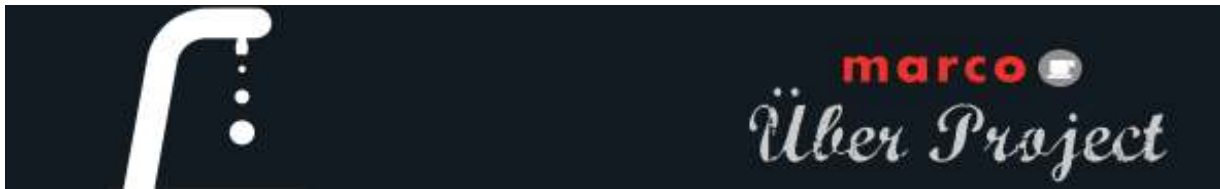

Principle of Operation of the Uber Boiler

- The Uber Boiler is designed to be a highly accurate hot water delivery system. This temperature accuracy is achieved by several features;
 - In stand-by the water is maintained at a set temperature [Prime Mode] this is controlled via a thermistor in the tank,
 - in the Boost Mode the hot water is circulated through the FONT (to reduce any temperature loss)
 - a second thermistor located in the FONT is now used to control the temperature of the water and therefore ensure the accuracy of the delivered water
 - a specialised software algorithm **APLogic™** is used to control the temperature within +/- 0.2°C,

Simplified operation :

1. The unit is preset to a Prime Temperature at the factory (this may be changed by the user). This is the stand-by mode and the temperature is displayed on the display panel as Tank Temp.
2. The user presses the Boost button and holds this button down until the desired set temperature is displayed on the display panel.
3. The Uber Boiler will now ramp the tank temperature from the Prime setting up to the Set Temp while recirculating the water through the Font.
4. When the set temperature is reached the user will rotate the Font Dial counterclockwise to start the flow of water.
5. To select another set temperature the user should press the Prime button – return the unit to the Prime Mode – and repeat step 2 to the new temperature.
6. If a user has several brews/volumes to dispense they should remain in boost mode where possible, otherwise the tank will refill with cold water when you return to Prime and will take approx 2min to heat each 1Litre of water. If you have several brews in a row at different temperatures it is best practice to do your colder brew first and then heat up while still in Boost, as you cannot cool down in boost mode.

FIRST OPERATION :

- Check that all installation procedures have been carried out.
- Ensure water valve is on.
- Plug boiler into 13A socket and press power switch on – located under the bottom of the Tank unit.
- See Photo 1 for location and name of each feature.



- The boiler unit will then take in water to the middle level probe and then commence heating. The display will show : PRIME FILL and the TANK TEMP: will show the temperature of the water in the tank.
- Once the temperature reaches value set as standby the boiler will continue filling the tank in short bursts to maintain constant temperature. The display will show PRIME READY at this stage and the BOOST button will be enabled.
- Once the water level in the tank has reached the high level probe (full) the heater will turn off and display will show PRIME READY FULL
- **The boiler is now ready for use**
- Use of the Time and Weigh Features:
 - Time : 00:00 – when the Timer Button is pressed the display will indicate time elapsed in minutes : seconds. This can be used to indicate the brewing time. Pressing the button once quickly will pause the current time which can be restarted again. Pressing the button for more than 2 seconds resets the Timer display to zero.
 - Weight : 0000 – this is in grams. Pressing the Weigh button will reset the weighing scale. The brewing vessel can be placed on the scale/drip tray and the display will show its weight. Pressing the Weigh button again will “zero” (tare) the scale so that when the coffee grind is added to the basket, its weight can be displayed. This is to help control the Coffee / Water ratio. 1ml of water weights approx 1gram.
 - 9kg is the max allowable weight on the scales. **DO NOT OVERLOAD**

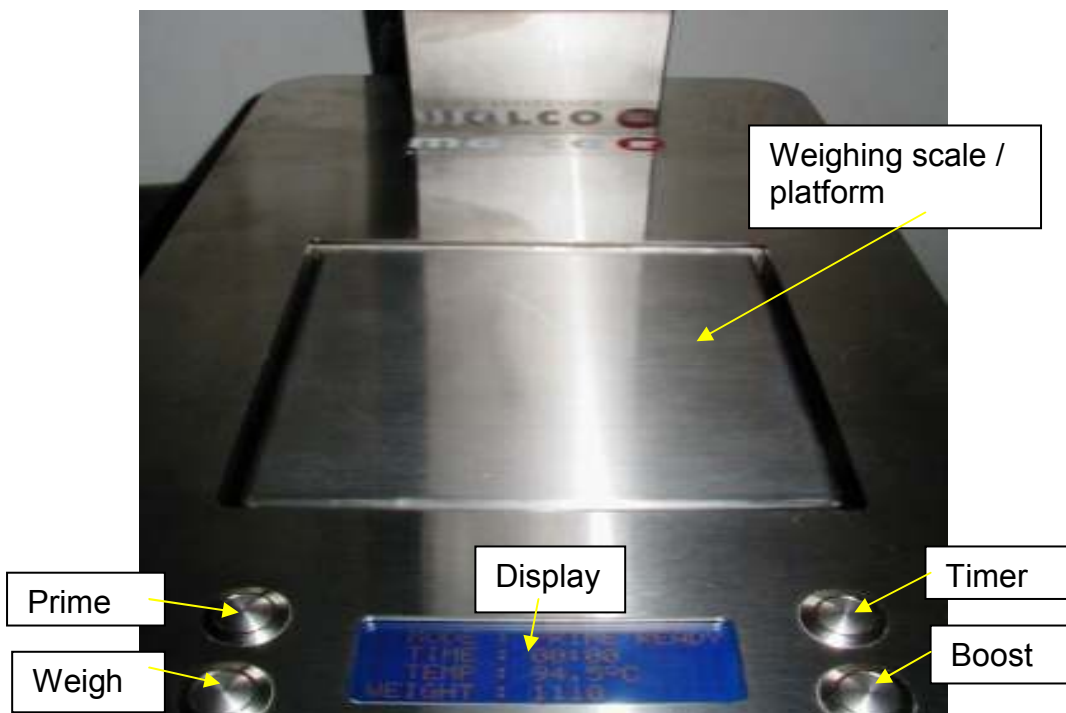

Photo 1



UNDERSTANDING THE DISPLAY AND CONTROLS:

The Display screen contains 4 lines of information:



1. First line on the display shows *status message*:

Status	Description
PRIME FILL	Tank is filling, not heating until reaches the middle level probe. Boost button disabled.
PRIME HEAT	Tank is heating, not filling until temperature in the tank reaches “Prime temp”. Boost button disabled.
PRIME READY	Tank is heating and refilling. Temperature is maintained around “Prime temp” value. Boost button is operational and puts machine into BOOST mode. Tank is not full yet.
PRIME READY FULL	Tank is heated up to the “Prime temp” and reheats once the temperature falls 0.5°C below “Prime temp”. Boost button is operational and puts machine into BOOST mode. Tank is full.
EMPTYING THE TANK	Pump is running allowing to dump all water from the tank through the font. Inlet disabled. Option triggered by pressing PRIME button for more than 5 seconds. Press PRIME again to quit.
BOOST TEMP: xx.x °C	Machine in BOOST mode. Water inlet disabled. Shows the target temperature set by pressing and holding BOOST button. Machine heats up to the set temperature and maintains it within ±0.2 °C. Press PRIME button to go back to PRIME mode.
LOW TANK LEVEL !	Machine in BOOST mode – Tank Level is below 2 litres. Only when in LARGE TANK Mode (Service Set up Menu #8)
Communication error!	Display board lost communication with boiler PCB (can not receive serial data about temperature and level probes). All actions cancelled. Whenever communication is restored, machine will go back to PRIME FILL mode.
---	Top water level probe covered while low level not. Check low level probe for scale. Boost button disabled.
Tank thermistor err!	Tank thermistor disconnected or short circuited. Boost button disabled.
Font thermistor err!	Font thermistor disconnected or short circuited. Boost button disabled.



2. The second line shows the live readout of:

- Tank temperature in PRIME mode,
- Font temperature in BOOST mode.

3. Third line shows the timer

- Clicking TIMER button turns on and off the timer clock.
- Pressing it for longer than 2 seconds resets it and turns it off.

4. Fourth line shows measured weight, scaled in grams.

- Numbers above 9999 can NOT be displayed – “----“ will be shown instead.
- Negative numbers will be shown with minus sign (down to -9999).
- Pressing WEIGH button will reset scale to zero.
- Please note that the max weight for the load cell is 4kg and any loads higher than 9kg may destroy it.

NOTE: Because the boiler is electronically controlled no priming is necessary.
The element cannot switch on until a safe level of water is reached.

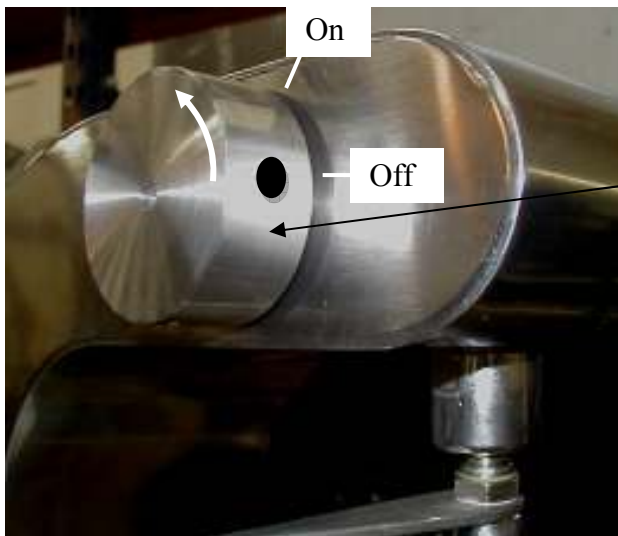

The Font Dial operates anticlockwise to begin the flow of water.

WARNING: ALWAYS ENSURE THE DIAL IS SET TO OFF BEFORE PRESSING BOOST OR HOT WATER WILL BE FLOWING IMMEDIATELY.



OPERATION MODES

PRIME MODE

After turning on or pressing PRIME button the machine goes into Prime Mode. This is a stand-by mode when the water is prepared for final dispense. The tank will fill to the middle level probe (PRIME FILL) and heat up (PRIME HEAT) to the preset temperature (*Prime temp* in calibration). Once the temperature gets above (*Prime temp* - 1°C) the display will show PRIME READY message and the BOOST button will be enabled. From this moment machine will be taking water in short bursts until it fills all the tank (heat fill cycle) and the message PRIME READY FULL will appear.

NOTE: The user may use water even before the tank is full. The amount of water available will be in the range between 2 and 6 litres.

Prime Mode logic is based on thermostatic principal – the water accuracy is around ±2°C from the set point.

Prime Mode status	Description	BOOST button
PRIME FILL	Tank fills to the top probe; heater off.	disabled
PRIME HEAT	Tank heats up to the preset <i>Prime temp</i>	disabled
PRIME READY	Tank temperature above (<i>Prime temp</i> - 1°C). The tank is still being filled (heat fill cycle).	enabled
PRIME READY FULL	Heat fill cycle finished. Tank is full.	enabled

To Empty the Tank.

In the Prime Mode the tank maybe emptied by Pressing and Holding the PRIME button for >5 seconds. This will switch on the Pump – Using the Dial on the FONT the tank may be emptied. To exit this mode press the PRIME button.

Note in the LARGE TANK setting it will empty approx. 8 Litres.

BOOST MODE

In Boost Mode the user sets the desired temperature. This is done by pressing BOOST to turn on the pump, and then repeatedly pressing the BOOST button to increase the SET TEMP (shown on the screen) in 0.1°C steps (holding down the button will quickly cycle it upwards). The set-up temperature range is between *Prime temp* and *Max temp*.



After setting-up the machine it will start to heat to the desired temperature and will maintain it within $\pm 0.2^{\circ}\text{C}$. The SET TEMP may be increased at any time by pressing the BOOST button. Pressing PRIME button will make the machine go back to Prime Mode and reset the SET TEMP back to *Prime temp*. The machine will refill when in Prime mode and so take time to heat back up again.



The Boost Mode is based on the Advanced Proportional Logic (APLogic™) control algorithm that controls the heating rate to avoid temperature overshoots..

User Setup (software ver 1.10)

To change the Prime Temperature setting and the Temperature Unit it is necessary to access the User Setup menu.

To enter User Setup press all four buttons on the front tile and then release them. While pressed the screen will show USER SETUP message in its first line.

Buttons on the left hand side change calibration option (up/down): See options below
 Buttons on right hand side adjust the calibrated value (up/down, press longer to repeat).

Screen view Options 1 – 2	Description	Default value
	Sets temperature at which the element clicks off in prime mode. The turning-on temperature is 0.5 degree below this point.	(89.0 for 2L) (90.0 for 6L)
	Sets temperature measurement units (Celcius / Fahrenheit)	Celcius
	Press TIME button to accept all the settings – they will be stored in the non-volatile memory. To cancel and come back to the previous settings – turn the machine off and on again.	

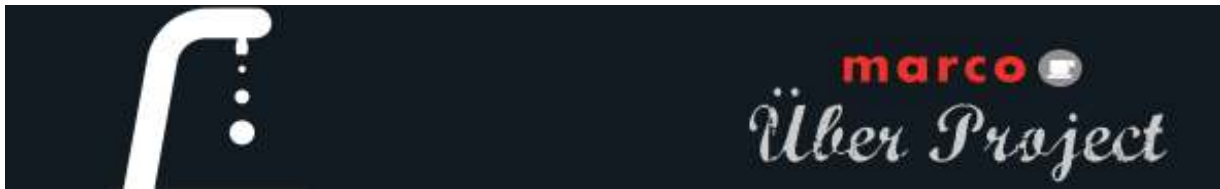

Service Setup (software ver 1.10)

The following information is for Calibration purposes and should not be required for normal use conditions.



To enter calibration mode press all four buttons on the front tile at the same time and hold them until SERVICE SETUP message will appear on the first line of the screen (approx. 5 seconds).

Buttons on the left hand side change calibration option (up/down): See options below

Buttons on right hand side adjust the calibrated value (up/down, press longer to repeat).

Screen view Options 1 – 10	Description	Default value
	Sets offset value for tank temperature sensor. The offset is the difference between absolute temperature and a measured one. It is factory set using calibrated instruments. TEMP shows live readout from tank sensor with the applied offset.	0.0
	Sets offset value for font temperature sensor. The offset is the difference between absolute temperature and a measured one. It is factory set using calibrated instruments. TEMP shows live readout from font sensor with the applied offset.	0.0
	Sets maximum temperature at which the element can be switched on. Both sensors (tank and font) are monitored, if any reading is above set value, the element switches off.	97.5
	Sets heating delta factor. This number tells the software how many energized seconds it will take to heat up the tank by one degree. This number is proportional to the size of the tank and inversely proportional to the power of the element. Setting value too high will make the machine overshoot too much; setting too low will make the process of reaching the set temperature slower. This value must be altered for different tank sizes and different voltages (see next page for info & table)	(8.0 for 2L) (13.0 for 6L) @230V

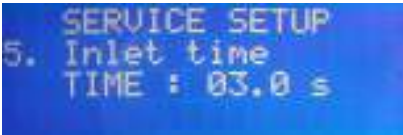

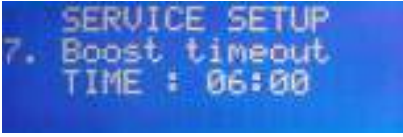
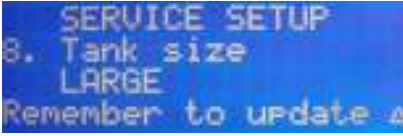
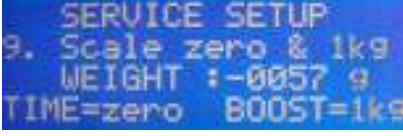
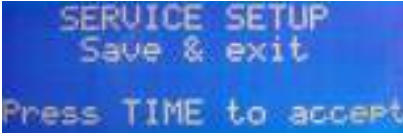
	<p>Sets the time for which the inlet opens every time the machine needs water. It minimises temperature fluctuations. The value should be picked to allow 0.5°C cooling after water intake and depends on the tank size and element power. This is a factory setting and should only be changed by trained personnel.</p>	<p>3.0</p>
	<p>Sets dead time (measured in seconds from the beginning of every heating cycle in BOOST mode) when software waits for the tank sensor to record temperature change. Value depends on element time constant and placement of the thermistor. Setting the value too high will make temperature swing too much in BOOST mode; setting too low will make machine overshoot too much.</p>	<p>00:12 (for both 2L &6L,)</p>
	<p>Sets BOOST mode time-out. Timer starts at the beginning of the BOOST mode. Machine goes back to PRIME mode after that time to avoid unit being left in Boost Mode for too long.</p>	<p>06:00</p>
	<p>This sets the tank volume (switching between 2 probes). LARGE is a ~6L drawoff and SMALL is a ~2L drawoff. In SMALL/2L mode the temperature increases faster (e.g. to boost from 90 to 96C will be quicker). There is no difference in recovery rates, i.e. if you take off 1Litre of water in either mode it takes ~2min for it to heat back to 90C. A 2L setting is typically used when you require lower brew volumes and more varied temperatures between brews.</p>	<p>-</p>
	<p>Calibrates weighing scale. 1kg weight is needed. Do NOT press any of the right hand side buttons if you don't have any reference weight! TIMER button sets scale to zero; BOOST button sets new value for 1kg. To recalibrate the scale:</p> <ul style="list-style-type: none"> - empty the weighing platform, - press TIMER button (reset scale to 0), - place 1kg calibration weight, - press BOOST button (set new value for 1kg) <p>WEIGHT shows live readout of the weight.</p>	<p>-</p>
	<p>Press TIME button to accept all the settings – they will be stored in the non-volatile memory. To cancel and come back to the previous settings – turn the machine off and on again.</p>	<p>-</p>



Delta Values [Step 5 in Uber Calibration]

The default Delta value is based on a 230V power supply and a Large/6L tank volume setting. Varying voltages & volumes require the Delta value to be changed to ensure optimal operation of the machine. The following are optimal settings for different voltages & tank sizes.

	Tank size: SMALL	Tank size: LARGE
Voltage	Delta Value	Delta Value
230V – 240V	6.0	13.0 (default)
208V	7.3	15.9
200V	8.0	17.2